

Energizer[®]

**SMART WIFI
LED LIGHT STRIP**

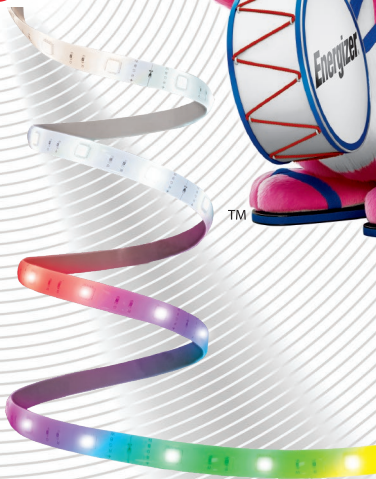

TM

QUICK START GUIDE

EIS2-1001

v1.2

GETTING STARTED

Thank you for choosing the **Energizer**® LED Light Strip. This quick start guide will help you with setup and installation.

Package Includes:

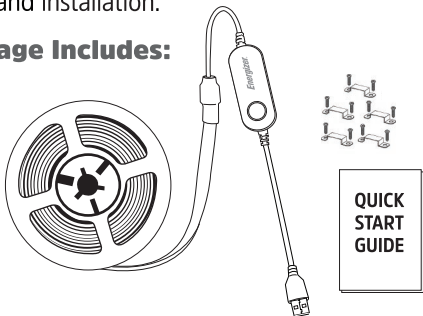

- 6.5ft LED Light Strip
- Smart LED Controller
- Mounting Clips
- Quick Start Guide

What You Need:



App



2.4GHz 5GHz



2.4GHz WiFi



Before setup, make sure your phone is connected to the 2.4GHz WiFi network that your device will be placed on. You may also need to turn on location and Bluetooth to find nearby networks.



CONNECT THE DEVICE

STEP 1

Download the free **Energizer**® Connect app from the App Store (for iPhones) or Google Play Store (for Android phones).



STEP 2

Make sure your mobile device is connected to your **2.4GHz WiFi** network.

Open the app and **click** "Create Account" by following the on-screen instructions.



After your initial sign in, your app will remember your password and log you in automatically. You can also choose to manually log out under Settings in the Main Menu.

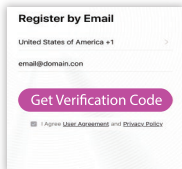

You may need to check your Spam folder for the verification code

STEP 3

Plug the power adapter into a power outlet.
The light strip should start flashing for pairing mode.

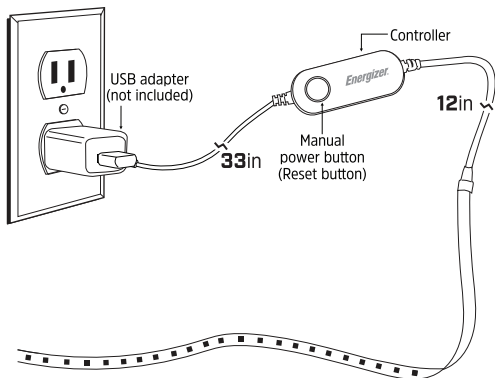

NOTE: The LED Light Strip should start blinking red rapidly (about 4 times per second) for EZ pairing mode.

LED Behavior	Device Status
Flashing Rapidly	EZ Pairing
Flashing Slowly	AP Pairing

Button Operation	
Single Click	Cycle through Color Options
Double Click	On/Off
Hold for 5 Seconds	Enter/Cycle through Pairing Modes



NOTE: Do not turn on LED strip and leave it on for an extended period of time while it is still wound up in the spool wheel.

STEP 4

After logging in, **click** “+” on the top right of the screen and **select** “Add device”.

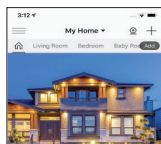

Click

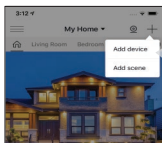

Select

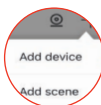

STEP 5

Select the Lighting category and **confirm** that the LED Light Strip is still rapidly blinking

Click “Confirm indicator rapidly blink”.

Select

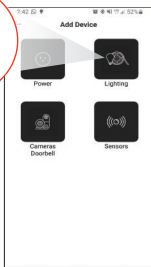

Help: Switch between pairing modes. See troubleshooting page 12.

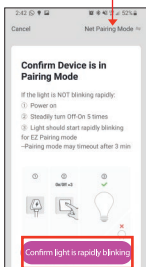

Confirm



Click

STEP 6

Confirm that the displayed **WiFi** network is your **2.4GHz WiFi** network, **enter** your WiFi password and **click** “Confirm”.

Confirm WiFi

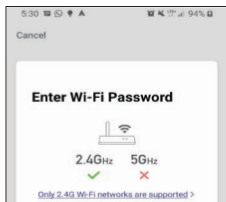

Enter and Click

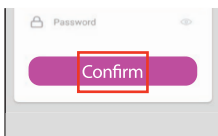

Help: If you need information about **2.4GHz WiFi** networks, click the link to go to our Connect FAQs on our website.

STEP 7

Your LED Light Strip will now be connected to the network. Confirm the settings for your device and then **Click** “Done”.



TIP: You can put your LED Light Strip directly in a room by selecting one of the available rooms. **Click** the  button to change the name of the product.

PROCESSING TIME

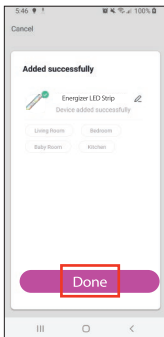
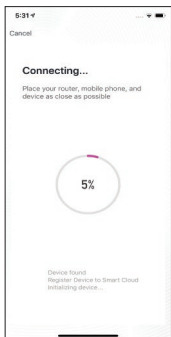

Your **Energiizer**® Smart LED Light Strip is now ready to use. You can now change color, dimness and set schedules. We hope you enjoy using your **Energiizer**® Smart LED Light Strip. For frequently asked questions and instruction videos, please visit our website at www.energiizerconnect.com

INSTALLATION

STEP 1

Determine where you will install the LED Light Strip.

- Make sure you install close enough to a power outlet (Power adapter cord is 6 feet and controller cable is 3 feet).
- Clean the mounting surface with a clean cloth and rubbing alcohol. Be sure to let this surface dry before installation.
- Note: For best mounting results, place adhesive onto desired surface with one attempt. Reapplying multiple times will not guarantee secure mounting onto surface.

STEP 2

Peel off the beginning of the adhesive backing and firmly stick the LED Light Strip onto the surface. Peel off more of the adhesive backing as you mount the LED Strip, pressing on each section of the strip for 10 seconds as you place it.



OPTIONAL

Using the included mounting clips and screws, and a phillips head screwdriver (not included), install the mounting clips over the LED Light Strip in equal intervals.

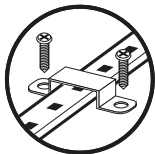

STEP 3

Plug the power adapter into a power outlet. If you have already connected your device it will automatically rejoin the network when you power it on.

STEP 4

Manually pressing the controller button will cycle the LED Light Strip through a few colors, preset modes or turn off. These settings can also be changed in the app.

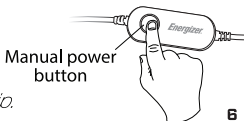

See troubleshooting on page 12 for information on cutting the strip.

APP CONTROL



This icon in the top right will take you to Device Settings

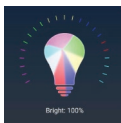

Turn ON and OFF your LED Light strip by tapping the bulb icon in the center of the screen.

The lines around the bulb will change based on your color and brightness settings.



Use scroll bar to adjust the brightness.

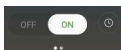

You can also tap the switch at the bottom for ON and OFF.

You can set schedules by clicking the clock button.

Swipe the entire screen from right to left to adjust the mode.

There are three main MODES to select from



Select for white



Choose a color



Select and edit decor scenes

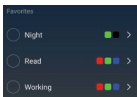

Select a scene for a colorful decor lighting effect!

You can edit the scene name, color sequence, color change effect and speed by clicking the arrow on the right side of the scene.

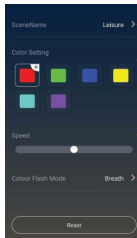

Change Scene Name

Select what colors and what order (Each scene can have a maximum of 6 colors)

Select the speed you want the colors to change

Select the way the colors change

Add and remove up to 15 favorite colors!

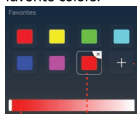

Adjust Saturation

Remove Favorite

Add Favorite

VOICE ACTIVATION

To enable voice access for your Smart LED Strip, you will need to link the **Energizer**® Connect skill with your choice of voice assistant.

Voice Activation for Alexa

Make sure your Alexa device is installed and set up first.

STEP 1

Open your Alexa app.

STEP 2

Open the menu to search for “Skills”.

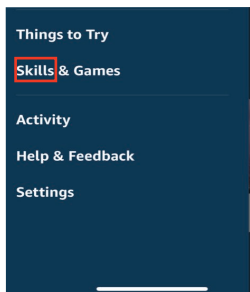

STEP 3

Search for & **choose** **Energizer**® Connect.

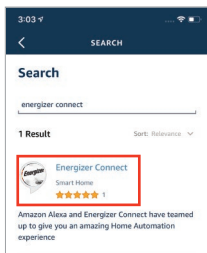
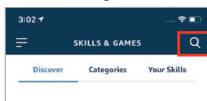

Choose

STEP 4

Authorize your account with the Alexa skill using the username and password from your **Energizer**® Connect app.

STEP 5

Using the name you assigned your LED Light Strip, you can ask Alexa to turn on/off your LED Light Strip.

Ex: “Alexa, change bedroom light strip to red”.

Voice Activation for the Google Assistant

Make sure your Google Assistant device is installed and set up first.

STEP 1

Open your Google Home app.

STEP 2

Click the "+" to add a new device.

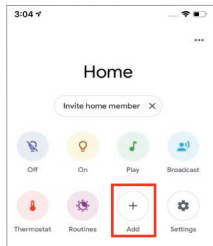

Click

STEP 3

Click "Set up device".

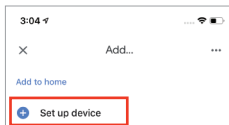

Click

STEP 4

Click "Have something already set up?"

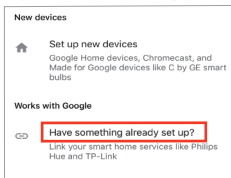

Click

STEP 5

Search for & choose **Energizer[®] Connect**.

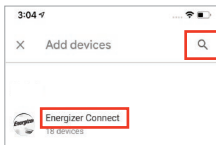

Choose

STEP 6

Authorize your account with the Google Assistant skill using the username and password from your **Energizer[®] Connect** app.

STEP 7

Using the name you assigned your LED Light Strip, you can ask the Google Assistant to turn on/off your LED Light Strip. Ex: "Ok Google, change bedroom light strip to red".

Voice Activation for Siri

STEP 1

Open the Energizer Connect app and click the “+” at the top right of the Home Screen and select “Add Scene”.

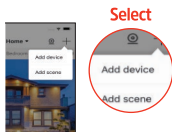

STEP 2

Select “Launch Tap To Run” and fill out the information.

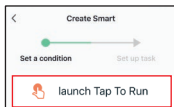

STEP 3

Once your Smart Scene is created, return to the Smart Scene manager by clicking on the three lines in the top left of the Home Screen to open the main Menu, and then selecting “Smart Scenes”.



STEP 4

Click the button at the bottom of the screen that says “Add to Siri”.

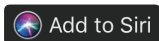

STEP 5

Select your new Tap to Run Smart Scene from the list and click “Add to Siri”.

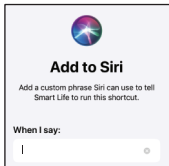

STEP 6

Create a custom phrase for Siri to run your Smart Scene.

(this can be any verbal command)

Now Siri can use your voice and custom verbal command to turn your LED Light Strip on or off, activate your favorite lighting pattern, adjust the device at the same time as your other smart devices, or whatever you've set up as your Tap To Run Smart Scene.

LEGAL & WARRANTY

To see Warranty information and Certification Legal warnings, please see our website.

www.energizerconnect.com

©2020 Energizer. Energizer, Energizer Bunny design and certain graphic designs are trademarks of Energizer Brands, LLC and related subsidiaries and are used under license by Jem Connected IOT, Inc. All other brand names are trademarks of their respective owners. Neither Jem Connected IOT, Inc. nor Energizer Brands, LLC is affiliated with the respective owners of their trademarks.

Apple and the Apple logo are trademarks of Apple Inc., registered in the U.S. and other countries.

App store is a service mark of Apple Inc.

Google, Android and Google Play are trademarks of Google LLC.

Amazon, Alexa and all related logos are trademarks of Amazon.com, Inc. or its affiliates.

FCC Compliance

This device complies with Part 15 of the FCC. Operation is subject to the following two conditions: (1) this device may not cause harmful interference, and (2) this device must accept any interference received, including interference that may cause undesired operation. Changes or modifications not expressly approved by the party responsible for compliance could void the user's authority to operate the equipment.

HAVING TROUBLE WITH SETUP?

Don't return this product to the retailer, we're here to help

Please call us at 888-693-4189 or visit www.energizerconnect.com for video tutorials, updated manuals and more FAQs for your device.

My device won't connect to my network!

- 1.** Make sure you are connected to your **2.4 GHz network** and your device is blinking red before you start trying to connect your device.
- 2.** You may need to reset your device if you are having trouble. Check out page 2 for the location of your device's reset button.
- 3.** To allow the app to locate the network, you may need to allow permissions for location and turn on your Bluetooth.
- 4.** If you are not certain what type of network you have, contact your Internet Service Provider and ask them to create a separate, dedicated **2.4GHz network**. You can also do this manually in your router's settings.
- 5.** Try moving to a spot closer to your router for connecting.
- 6.** You can also purchase a WiFi extender to increase your WiFi range and strength.
- 7.** In some cases, you can try using the secondary pairing mode by clicking "Net Pairing Mode" on the Add Device screen (see bottom of page 3). Follow the on-screen instructions.

I want to cut the strip to fit a smaller space. What should I know?

Cutting the strip will void your warranty. However, if you want to cut the strip into a smaller length, follow these instructions to do so safely and effectively:

- 1.** Make sure that the strip is disconnected from the power supply.
- 2.** Measure the length that you require from the cable/controller side*.
- 3.** Cut through the middle of the gold connectors following the scissor icon arrow.
- 4.** Discard the piece that you cut from the end of the strip.



***TIP:** Measure from the correct side, and measure twice before you cut. There is no way to reattach a cut strip.

